

Article number: 2310307125ESD

Description: E+G Antistatic base for levelling elements
LV.A-60-14-AS-M8x68-ESD-C

Measures

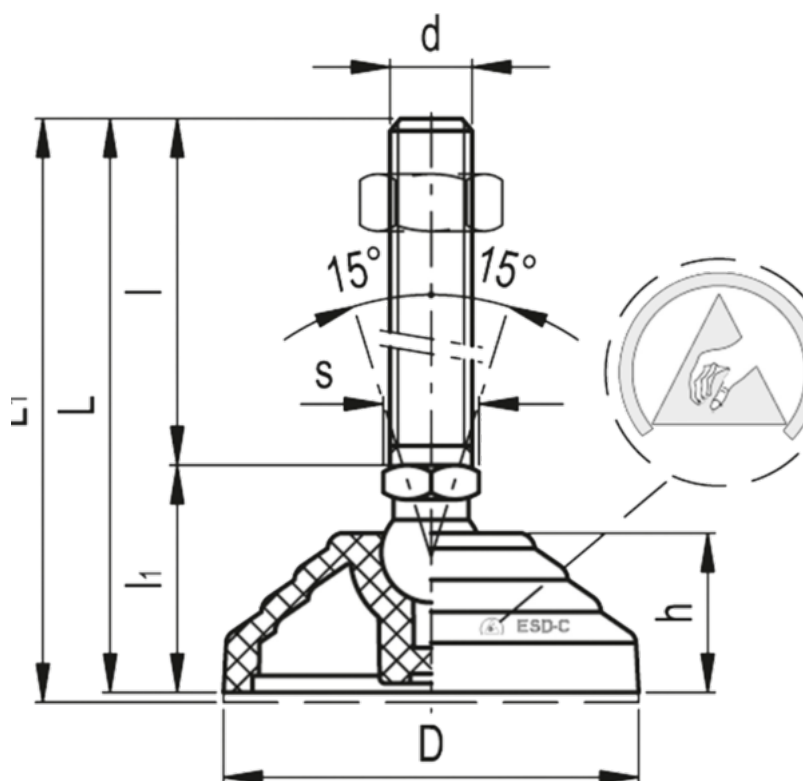

Articulation	= 14	Max load	= 14000
D	= 60	s	= 14
d	= M8	Weight in (g)	= 93
h	= 24		
l	= 68		
L1	= 33		
L	= 101		
L1	= 104		